



Dock Edging

Product Configuration

Item 5000  Commercial Dock Edging – 10'

Product Specifications

Material: Polyvinyl chloride extrusion compound

Color: Black or White

Weight: 6.20 lbs. per 10' length (nominal)

Packaging Specifications

Edging is shipped in straight lengths.
14 pieces per box, 20 boxes per crate.

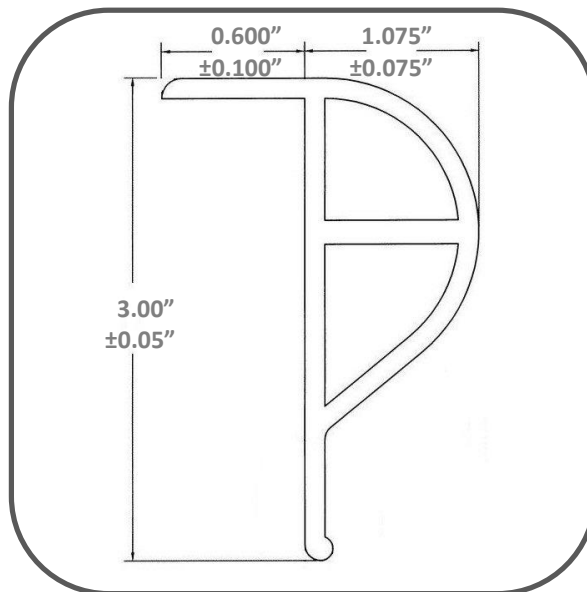

Physical Property Testing

Commercial Dock Edging products pass the following:

Specific Gravity	ASTM D-792	1.4 Nominal Value
Durometer	ASTM D-2240	85 Nominal Value
Accelerated UV Weathering	ASTM D-4329 at 50° C	No Failure
Fungus Growth	ASTM G-21	No Failure
Cold Flexibility	1 Inch OD mandrel bend at 29° C	No Failure
Flammability	FMVSS302	Passed
Tensile Strength	ASTM D624 Die C	12.4 Minimum
Elongation %	ASTM D624 Die C	200% Minimum
Tear Strength	ASTM D624 Die C	44 Minimum